

Motor Cam Switches, Type R, Door or Thru Panel Mounting



COMPLY WITH RULES

IEC 947-3, EN 60947-3, UL508

SERIES		P012-P016-P020 PX12-PX16-PX20			C025-C032-C040 CX25-CX32-CX40			C063-C080		G125		G200	
Protection class	control EN 60529 (UL50) NEMA 4X control with knob only terminals	IP65 (Type 1 - 4 -4X) IP40 IP20 (P0) - IP10 (PX)			IP65 (Type 1 - 4 -4X) IP40 IP20 (P0) - IP10 (PX)			IP65 IP40 IP00		IP65 - IP00		IP65 - IP00	
Material group	EN 60947-1	II			II			II		IIIA		IIIA	
Pollution grade	EN 60947-1	3			3			3		3		3	
Flammability	UL94	VO (Live Electrical parts)			VO (Live Electrical parts)			VO (Live Electrical parts)		VO (Live Electrical parts)		VO (Live Electrical parts)	
Ambient temperature	°C °C	Operating: -40 +85 Storage: -40 +70			Operating: -40 +85 Storage: -40 +70			Operating: -40 +70 Storage: -40 +70		Operating: -15 +55 Storage: -25 +70		Operating: -15 +55 Storage: -25 +70	
Climate Withstand	IEC 68 part 2-3 IEC 68 part 2-30	Hot damp Unsettled hot damp			Hot damp Unsettled hot damp			Hot damp Unsettled hot damp		-		-	
Terminal screw identification		EN50013			EN50013			EN50013		-		-	
Connections	Terminal block caliber EN60947-1 Terminal screw Screwing torque EN60947-1	A3 M3,5 0,8 Nm (7,2 lb. in.) 7,5 lb. in. (0,85 Nm)			A5 M4 1,2 Nm (10,6 lb. in.) 12 lb. in. (1,4 Nm)			A7 2xM4 1,2 Nm (10,6 lb. in.) 10,62 lb. in. (1,2 Nm)		Hex. screw M8 for bars and cable lugs		Hex. screw M10 for bars and cable lugs	
Connectable section	Flexible conductors min/max mm² AWG Solid conductors min/max mm² AWG	1x0,75/4 - 2x0,75/2,5 10 - 18 1x0,75/4 - 2x0,75/2,5 10 - 18			2x2,5/10 14 - 6 2x2,5/10 14 - 6			2,5/35 14 - 3 2,5/35 14 - 3		-		-	
Contacts		Double breaking			Double breaking			Double breaking		Double breaking		Double breaking	
Opening angles		30° - 45° - 60° - 90°			30° - 45° - 60° - 90°			45° - 60° - 90°		60° - 90°		60° - 90°	
Mechanical lifetime at 120 operations for hour	mil./cl	1	1	1	1	1	1	1	1	0,1	0,1	0,1	0,1
Electrical lifetime at 120 operations for hour	mil./cl	1	0,75	0,75	1	0,75	0,75	0,5	0,25	0,01	0,01	0,01	0,01
CERTIFICATIONS		P012 PX12	P016 PX16	P020 PX20	C025 CX25	C032 CX32	C040 CX40	C063	C080	G125	G200		
CE	CE mark - Europe	■	■	■	■	■	■	■	■	■	■	■	
cUL	cUL Listed - USA and Canada	●	●	●	●	●	●	●	●	●	●	●	
IMQ	IMQ Istituto Marchio Qualità - Italy	●	●	●	●	●	●	●	●	●	●	●	
CCC	CCC Cina	●	●	●	●	●	●	●	●	●	●	●	
EAC	EAC Russia	●	●	●	●	●	●	●	●	●	●	●	

■ Comply to the requirements by passed test. ● Approved.

Motor Cam Switches, Type R, Door or Thru Panel Mounting

EN 60947-3 CHARACTERISTICS			PO12 - PX12	PO16 - PX16	PO20 - PX20	CO25 - CX25	CO32 - CX32	CO40 - CX40	CO63	CO80	G125	G200
Rated operating voltage Ue	V		690	690	690	690	690	690	690	690	690	690
Rated insulation voltage Ui	V		690	690	690	690	690	690	690	690	690	690
Rated impulse withstand voltage Uimp (sectionable)	kV		4	4	4	6	6	6	8	8	6	6
Rated thermal current Ith	A		16	20	25	32	40	50	85	100	150	225
Rated thermal current in enclosed Ithe	A		12	16	20	25	32	40	85	100	150	225
Frequency	Hz		50/60	50/60	50/60	50/60	50/60	50/60	50/60	50/60	50/60	50/60
RATED OPERATING CURRENT Ie: alternate current			PO12 - PX12	PO16 - PX16	PO20 - PX20	CO25 - CX25	CO32 - CX32	CO40 - CX40	CO63	CO80	G125	G200
AC-21A Switching resistive loads with light overloads	690V	A	12	16	20	25	32	40	63	80	125	200
AC-22A Switching mixed resistive and inductive loads at light overloads	690V	A	12	16	20	25	32	40	63	80	125	200
AC-23A Periodic switching of motors	single phase - 1 pole	110V A/kW	12/1,1	14/1,5	18/2	25/1,5	30/2,2	35/3	45/4	63/5,5	-	-
		230V A/kW	12/2,2	14/3	18/4	25/4	30/5,5	35/6,5	45/7,5	63/11	-	-
		230V A/kW	10/3	14/4	16/5	25/7,5	30/9	35/11	50/15	58/18,5	140/45	169/55
		400V A/kW	10/5,5	14/7,5	16/9	22/11	24/15	32/18,5	40/22	54/30	78/45 (415V)	95/55 (415V)
		500V A/kW	10/7,5	14/10	16/11	22/11	27/18,5	32/22	40/30	54/37	65/45	79/55
AC3 Starting of cage motors (Interruption hile running)	single phase - 2 poles	110V A/kW	10/0,75	12/1,1	16/1,5	22/1,1	25/1,5	30/2,5	36/3,7	45/4	-	-
		230V A/kW	10/2	12/2,2	16/3,5	22/3,7	25/4	30/5,5	36/6,5	45/7,5	-	-
		230V A/kW	8/2,2	10/3	12/4	18/5,5	23/7,5	27/9	37/11	47/15	115/37	140/45
		400V A/kW	8/4	10/5	12/6	18/7,5	23/11	27/15	35/18,5	44/22	64/37 (415V)	78/45 (415V)
		500V A/kW	8/5,5	10/7,5	12/8	18/11	23/15	27/18,5	35/22	44/30	53/37	64/45
Nominal interruption power AC-23A (cosφ 0,45)		230V A	80	104	128	200	240	280	400	464	-	-
		400V A	80	104	128	176	216	256	320	432	-	-
		500V A	80	112	128	176	216	256	320	432	-	-
		690V A	80	112	128	160	176	200	256	320	-	-
Power dissipation for each pole	W	0,3*	0,35*	0,4*	-	-	-	-	-	-	-	
RATED OPERATING CURRENT Ie: direct current			PO12 - PX12	PO16 - PX16	PO20 - PX20	CO25 - CX25	CO32 - CX32	CO40 - CX40	CO63	CO80	G125	G200
DC-21A Switching resistive loads with light overloads	50V (1 phase)	A	10	12	16	20 ▼	25 ▼	32 ▼	-	-	-	-
DC-22A Switching mixed resistive and inductive loads at light overloads	30V (1 phase)	A	8	10	12	16 ▼	20 ▼	25 ▼	-	-	-	-
SHORT CIRCUIT CHARACTERISTICS			PO12 - PX12	PO16 - PX16	PO20 - PX20	CO25 - CX25	CO32 - CX32	CO40 - CX40	CO63	CO80	G125	G200
Rated short-time short circuit withstand current Icw (1 s)	A		300	300	300	500	500	500	1200	1200	-	-
Rated short circuit making capacity Icm	A		1200	1200	1200	2840	2840	2840	2000	2000	-	-
Conditional rated short circuit withstand current	kA		5	5	5	10	10	10	10	10	20	20
Fuse rating gG	690V	A	20	20	20	40 ■	40 ■	40 ■	100	100	125 ▲	200 ▲
UL 508 CHARACTERISTICS			PO12 - PX12	PO16 - PX16	PO20 - PX20	CO25 - CX25	CO32 - CX32	CO40 - CX40	CO63	CO80	G125	G200
General Use	600V AC	A	12	16	20	25	32	40	63	85	125	175
Standard motor load	single phase - 2 poles	120V AC HP (FLA)	0,5 (9,8)	1 (16)	1,5 (20)	1,5 (20)	2 (24)	3 (34)	5 (56)	5 (56)	-	-
		240V AC HP (FLA)	1 (8)	1,5 (10)	2 (12)	3 (17)	5 (28)	5 (28)	7,5 (40)	10 (50)	-	-
	3 phases - 3 poles	200V AC HP (FLA)	1,5 (6,9)	3 (11,04)	5 (17,5)	7,5 (25,3)	7,5 (25,3)	10 (32,2)	-	-	10 (56)	15 (84)
		240V AC HP (FLA)	3 (9,6)	5 (15,2)	5 (15,2)	7,5 (22)	7,5 (22)	10 (28)	15 (42)	20 (54)	20 (54)	25 (68)
		480V AC HP (FLA)	5 (7,6)	7,5 (11)	10 (14)	15 (21)	20 (27)	20 (27)	30 (40)	40 (52)	40 (52)	50 (65)
		600V AC HP (FLA)	5 (6,1)	7,5 (9)	10 (11)	15 (17)	20 (22)	20 (22)	40 (41)	50 (52)	50 (52)	50 (52)

▼ Values not reported on the IMQ files. ■ Fuses type gG 40a 500V ▲ Fuses type gG/Gm

Motor Cam Switches, Type R, Door or Thru Panel Mounting

| RANGE AC21A | 12A - 16A - 20A |

SCREW FIXING

Ø22 FIXING

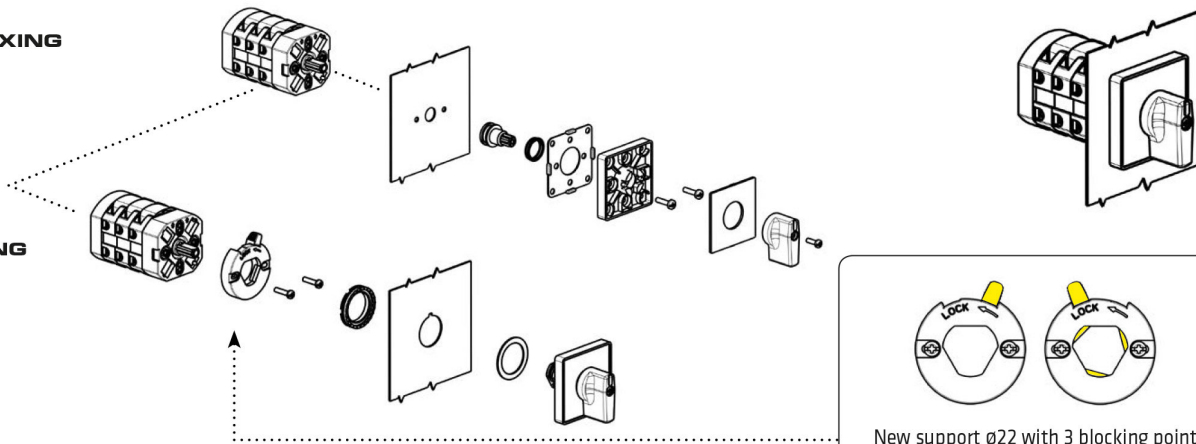

| RANGE AC21A | 25A - 32A - 40A |

SCREW FIXING

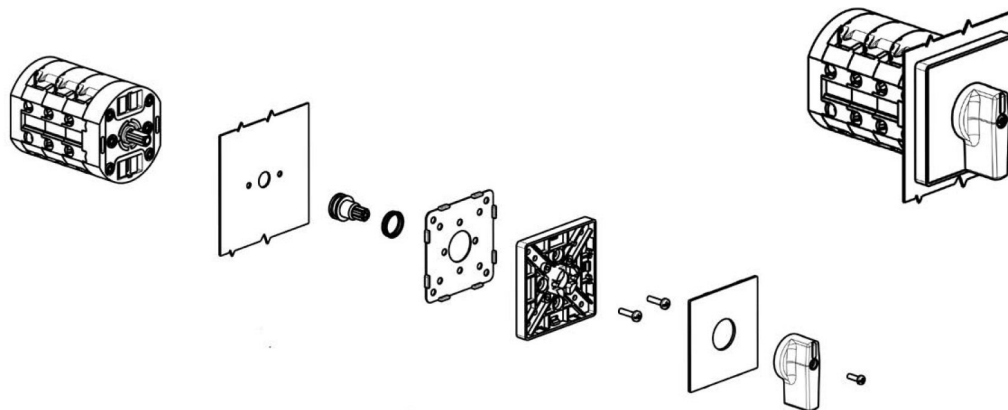

| RANGE AC21A | 63A - 80A |

SCREW FIXING

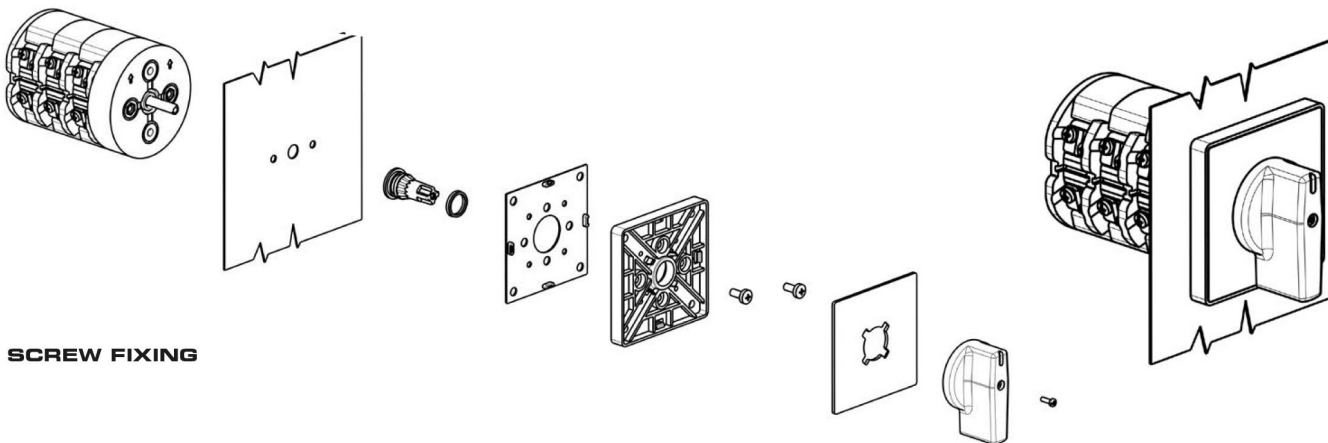

| RANGE AC21A | 125A |

SCREW FIXING

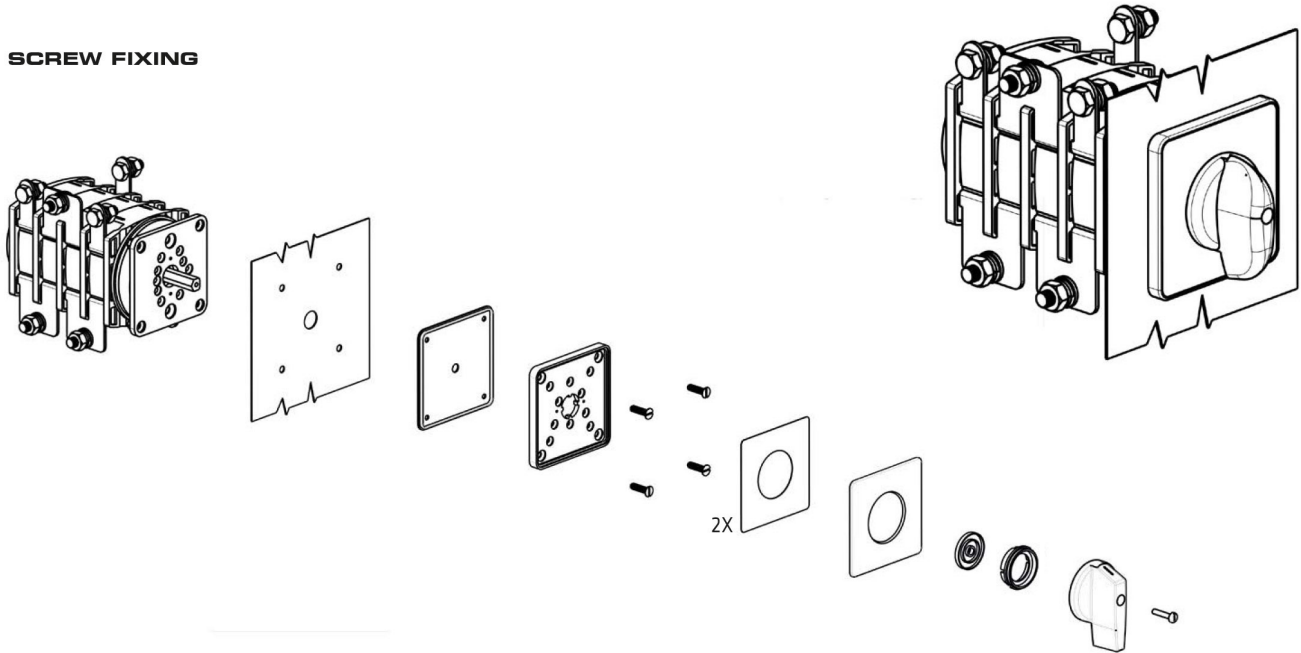

| RANGE AC21A | 200A |

SCREW FIXING

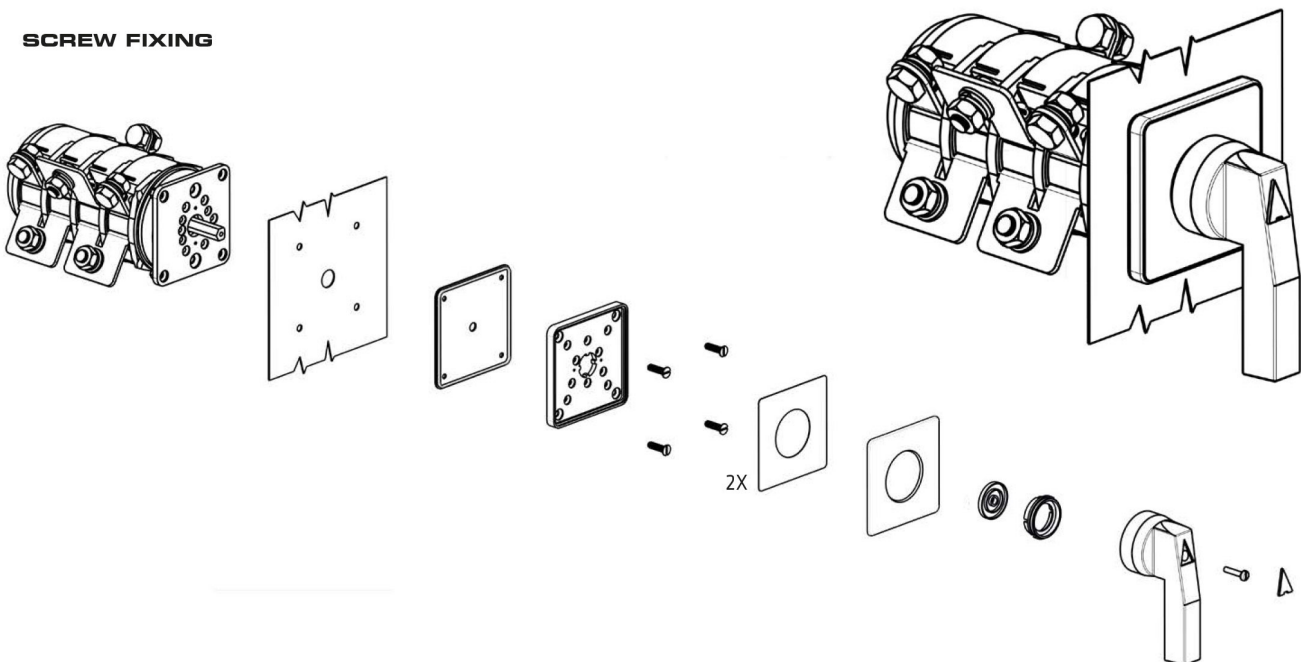

Motor Cam Switches, Type R, Door or Thru Panel Mounting



12-16-20A

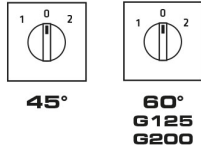

25-32-40A

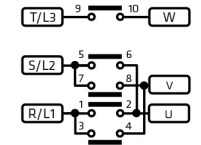

63-80A

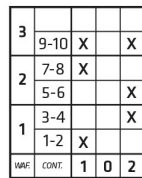



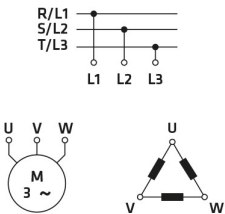



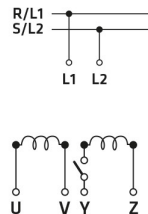
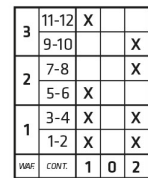
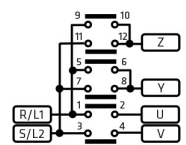
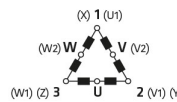
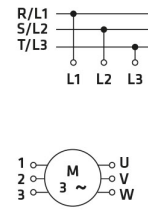
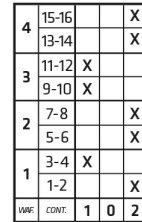
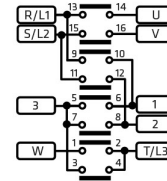
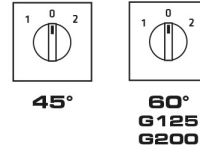
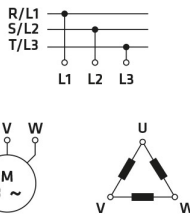
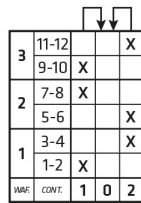
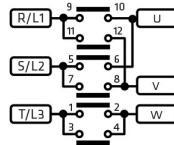









125A



200A



SERIES	AC21A	REVERSING SWITCH 3 POLES	REVERSING SWITCH 3 POLES WITH SPRING RETURN TO ZERO	DAHLANDER POLE CHANGING TWO SPEED SWITCH	REVERSING SWITCH SINGLE PHASE WITH CENTRIFUGAL CUT-OUT
P012	12A	P0120012R	P0120013R	P0120014R	P0120016R
P016	16A	P0160012R	P0160013R	P0160014R	P0160016R
P020	20A	P0200012R	P0200013R	P0200014R	P0200016R
C025	25A	C0250012R	C0250013R	C0250014R	C0250016R
C032	32A	C0320012R	C0320013R	C0320014R	C0320016R
C040	40A	C0400012R	C0400013R	C0400014R	C0400016R
C063	63A	C0630012R	-	C0630014R	-
C080	80A	C0800012R	-	C0800014R	-
G125	125A	G1250012R	-	G1250014R	-
G200	200A	G2000012R	-	G2000014R	-

ACTUATOR	FIXING	P012 - P016 - P020			C025 - C032 - C040		C063 - C080	G125	G200
		 45°	 45°	 NO	 45°	 45°	 45°	 60°	 60°
	screw	001/0008	001/0013	-	007/0008	007/00013	201/0008	441/0008	461/0008
	ø22	056X/0008	056X/0013	-	-	-	-	-	-
	screw	002/0008	002/0013	-	008/0008	-	-	-	-
	ø22	058X/0008	058X/0013	-	-	-	-	-	-
	screw	003/0008	003/0013	-	003/0008	003/0013	-	-	-
	ø22	059X/0008	059X/0013	-	-	-	-	-	-
	screw	004/0008	004/0013	-	004/0008	004/0013	-	-	-
	ø22	060X/0008	060X/0013	-	-	-	-	-	-
	screw	009/0008	009/0013	-	009/0008	009/0013	209/0008	-	-
	ø22	061X/0008	061X/0013	-	-	-	-	-	-
	screw	010/0008	010/0013	-	010/0008	010/0013	210/0008	-	-
	ø22	062X/0008	062X/0013	-	-	-	-	-	-
	ø22	057X/0008-CA	057X/0013-CA	-	-	-	-	-	-
	ø22	-	-	028X	-	-	-	-	-
	ø22	-	-	029X	-	-	-	-	-

-  UL50 NEMA Type 1-4-4X
-  Key removable at "0" position
-  Body mounting rotated by 90°
-  Key removable at 0° and 180°



12-16-20A

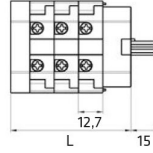
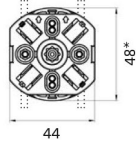

WAFER GAP	L x WAFER N°					
	1	2	3	4	5	6
12,7	37,4	50,1	62,8	75,5	88,2	100,9

* If cam switch is provided of external bridge (wafer to wafer) the height will be increased of ~ 2 mm for the lower and upper sides.



25-32-40A

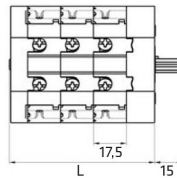
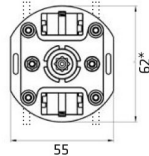

WAFER GAP	L x WAFER N°					
	1	2	3	4	5	6
17,5	42,2	59,7	77,2	94,7	112,2	129,7

* If cam switch is provided of external bridge (wafer to wafer) the height will be increased of ~ 1 mm for the lower and upper sides.



63-80A

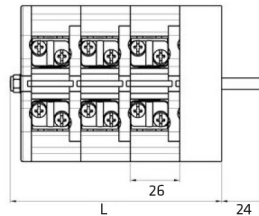
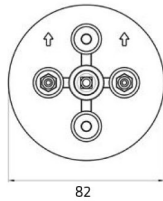

WAFER GAP	L x WAFER N°					
	1	2	3	4	5	6
26	59,1	85,1	111,1	137,1	163	189,1



125A

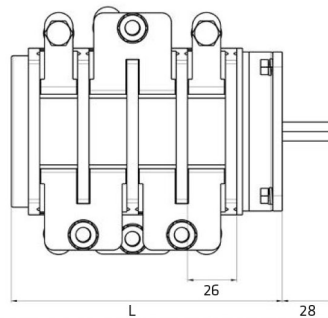
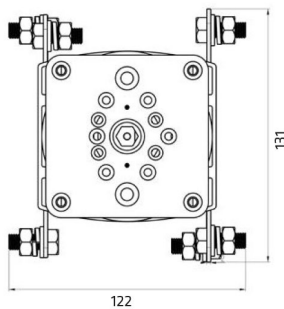

WAFER GAP	L x WAFER N°					
	1	2	3	4	5	6
26	66	92	118	144	170	196



200A

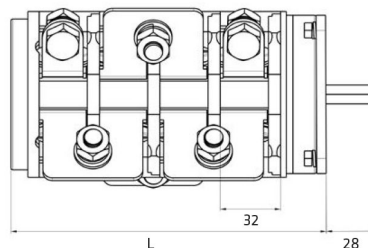
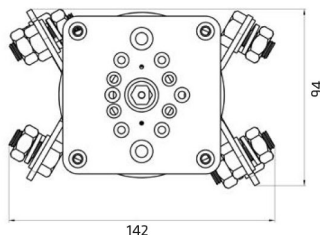

WAFER GAP	L x WAFER N°					
	1	2	3	4	5	6
32	72	104	136	168	200	232

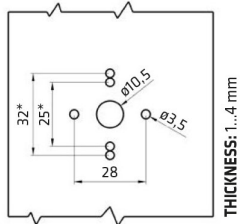

THICKNESS: 1...4 mm

FIXING:
Captive M3 bolt - 28 mm
* ALTERNATIVE FIXING
Screwplast 25 or 32 mm

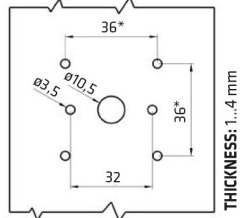
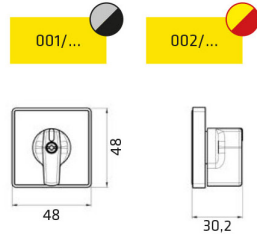

THICKNESS: 1...4 mm

FIXING:
Captive M3 bolt - 32 mm
* ALTERNATIVE FIXING
Screwplast 36 mm

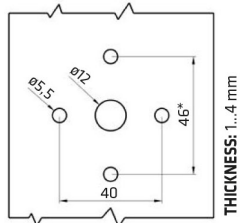
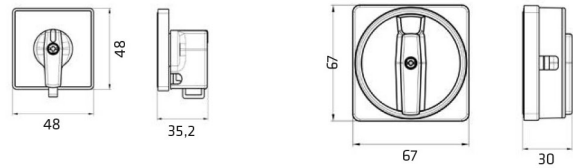
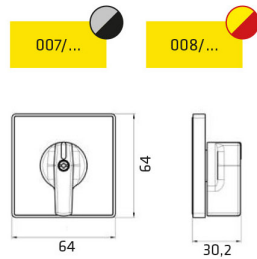

THICKNESS: 1...4 mm

FIXING:
Captive M5 bolt - 40 mm
* ALTERNATIVE FIXING
M5 - 46 mm

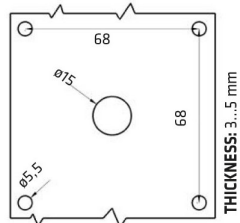
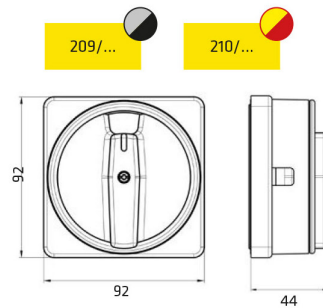
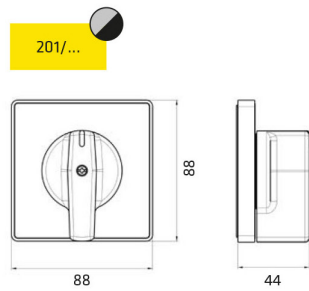

THICKNESS: 3...5 mm

FISSAGGIO:
M5 bolt 68 mm

