

- Modular, DIN Rail Mounting
- Shock Hazard Proof, Fully Insulated Connections
- Locking Hinged Cover for Easy Wiring Access
- Individual Snap On Marking Labels
- Accepts Red, Blue and Yellow Ring Tongue Terminals

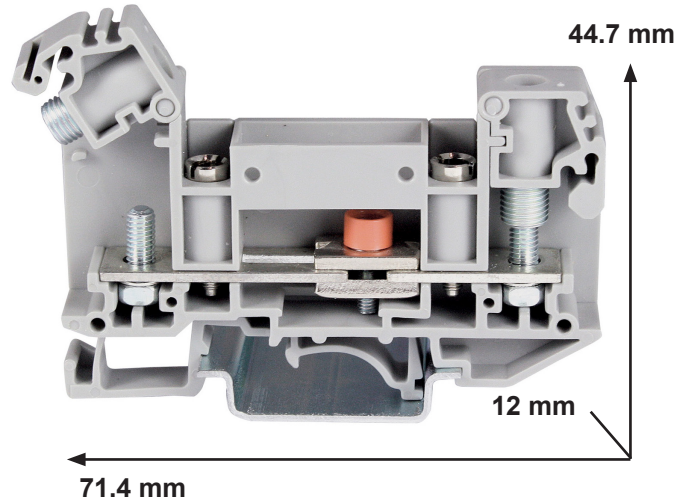

Dimensions

Length/Width/Height (mm) 71.4 x 12 x 44.7



Technical Parameters

Voltage (V)	600	Screw Size	M4
Current (A)	40	Torque (in-lbs)	13.5-15.5
Wire Range (AWG)	26-8	Stripping Length (mm)	8

Accessories

ASI272008	End Cover
ASIUD1B	End Stop/End Clamp
ASIZB810B	Strip of 10 Blank Markers
2054070	Type GF-M4, Ring Lug Terminal Yellow, 12-10 AWG
2050150	Type RF-M4, Ring Lug Terminal Red, 22-16 AWG
2052150	Type BF-M4, Ring Lug Terminal Blue, 16-14 AWG
2054650	Type GF-U4, Fork Lug Terminal Yellow, 12-10 AWG
2050710	Type RF-U4, Fork Lug Terminal Red, 22-16 AWG
2052710	Type BF-U4, Fork Lug Terminal Blue, 16-14 AWG
ASI302002	Ferrule Crimp Tool, 22-10 AWG
CCH06	Type CCH/6, Screwdriver
CCV05	Type CCV/5, Screwdriver
PR005	Steel DIN Rail, 35 x 7.5mm, slotted, 6'7" inch (2 meter)
PR005-1m	Steel DIN Rail, 35 x 7.5mm, slotted, 3'3" inch (1 meter)
ASI305001	DIN Rail Cutter