

DESCRIPTION

Giovenzana's standard micro switches with self cleaning contacts, supplied with operator, are high-precision, snap action switches and these are the main features for which they are notable:

- Fast and reliable switching largely independent of actuating speed
 - High electrical ratings but small dimensions
 - High repeat accuracy of switching points and forces
 - Low operating force
 - NC positive opening
 - Very long service life
 - Equipped with self cleaning switching contacts in silver alloy
 - Available with the pin plunger or various type of actuation lever.
- Easy adaptation to numerous applications such as joystick, TV game, time recorder, air conditioner, food processor, juice maker, alarm, mixer, shredder machine, ...

We've five lines of micro switches:

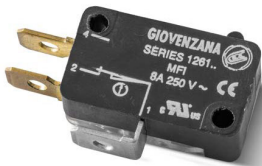

MFI series

Micro switches, normalized with self-cleaning contacts including actuating lever with 7 different versions.

- Faston terminal 6.3 x 0.8



MFI.S series

Micro switches, normalized with self-cleaning contacts including actuating lever with 7 different versions.

- Solder micro switches



MFI.ST series

Micro switches, normalized with self-cleaning contacts including actuating lever with 7 different versions.

- Screw terminal



MFI.STP series

Micro switches, normalized with self-cleaning contacts including actuating lever with 7 different versions.

- Screw terminal and plate protection



MFI.T

Micro switch with tower actuator



QUALITY MARKS



STANDARDS & APPROVALS

Standards	IEC/EN61058, UL1054
Approvals	cRUus, CE for all applicable directives

STRUCTURE DESCRIPTION

SINGLE-BREAK CHANGEOVER MFI Micro switch

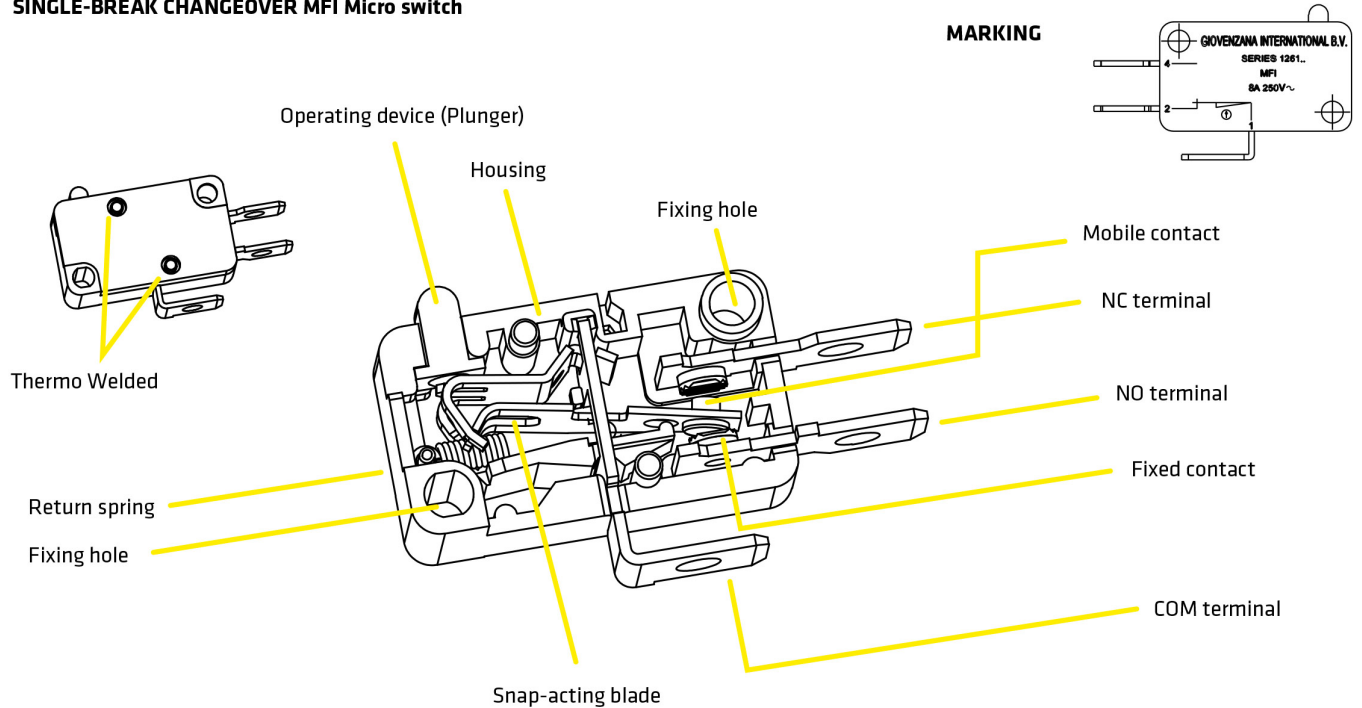

Micro switches are activated by a spring-operated (or snap-action) mechanism. Depressing the actuator triggers the switching operation, with a pre-defined force and travel. The switching speed itself is largely independent of the speed of actuation.

ACTIONING LEVERS

It is possible to attach an actioning lever to a snap switch in order to meet the specific requirements of a given application. Doing so usually alters the travel and forces involved in the switching operation, depending on the length of the levers. By attaching an appropriate actioning lever, it is possible to increase travel and/or reduce actuating force required.

OPERATIONING DEVICE (PLUNGER)

Applying force to the actioning lever of a snap switch releases the snap action mechanism, which in turn triggers the switching operation.

POSITIVE OPENING



An additional internal mechanism, made of non-resilient parts, forces the opening of NC contacts in case of accidental welding (overload, short circuit, ...) or snap action mechanism failure. Models fitted with this function are particularly suitable for safety related applications according to ISO13849-1 or EN60204-1.

To ensure proper functioning of positive opening operation, the operating device must be depressed up to the positive opening position.



MFI - CODE SELECTION OVERVIEW

M F I
SERIES

MFI
micro switches

ACTUATOR

blank pin plunger
1 long roller lever
2 simulated roller lever
3 roller lever
4 long lever
5 medium lever
6 short lever
7 16 mm roller lever

TERMINAL TYPE

blank 6.3 × 0.8 mm faston
S solder
ST screw
STP screw + plate protection
T tower actuator with threaded flange

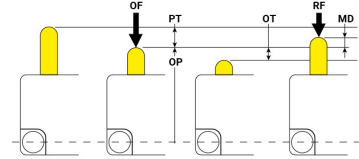

OF	[N]	Operating Force
RF	[N]	Release force
PT	[mm]	Pretravel
OT	[mm]	Overtravel
MD	[mm]	Differential movement
OP	[mm]	Operating position

Pin plunger



MFI

MFI.S

MFI.ST

MFI.STP

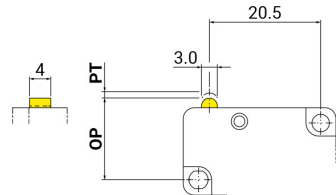

OF	max	5.1 N
RF	min	1.9 N
PT	max	1.4 mm
OT	min	0.8 mm
MD	max	0.3 mm
OP		14.4 ± 0.5 mm

Long roller lever



MFI.1

MFI.1S

MFI.1ST

MFI.1STP

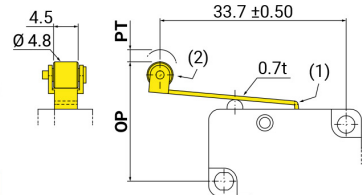

OF	max	3.2 N
RF	min	1.0 N
PT	max	3.3 mm
OT	min	0.8 mm
MD	max	0.8 mm
OP		17.4 ± 0.8 mm

Simulated roller lever



MFI.2

MFI.2S

MFI.2ST

MFI.2STP

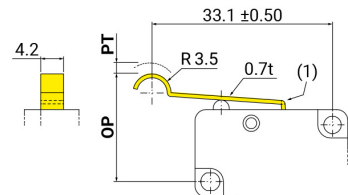

OF	max	3.2 N
RF	min	1.0 N
PT	max	3.3 mm
OT	min	0.8 mm
MD	max	0.8 mm
OP		17.4 ± 0.8 mm

Roller lever



MFI.3

MFI.3S

MFI.3ST

MFI.3STP

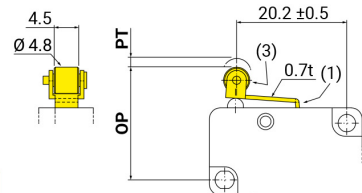

OF	max	5.1 N
RF	min	1.9 N
PT	max	1.4 mm
OT	min	0.6 mm
MD	max	0.6 mm
OP		20.3 ± 0.8 mm

Long lever



MFI.4

MFI.4S

MFI.4ST

MFI.4STP

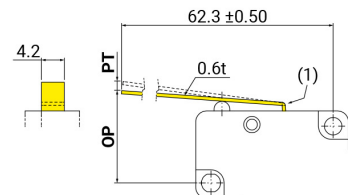

OF	max	1.3 N
RF	min	0.15 N
PT	max	7.6 mm
OT	min	2.2 mm
MD	max	2.2 mm
OP		15.1 ± 2.6 mm

Medium lever



MFI.5 **MFI.5S** **MFI.5ST** **MFI.5STP**

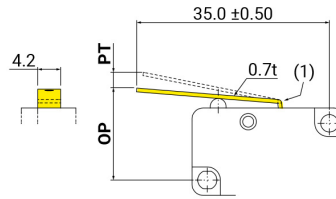

OF	max	3.2 N
RF	min	1.2 N
PT	max	3.3 mm
OT	min	0.8 mm
MD	max	0.8 mm
OP		15.1 ± 1.2 mm

Short lever



MFI.6 **MFI.6S** **MFI.6ST** **MFI.6STP**

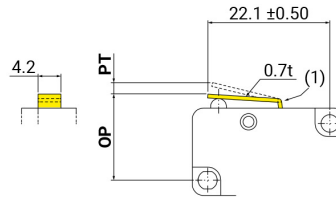

OF	max	5.1 N
RF	min	1.9 N
PT	max	1.6 mm
OT	min	0.6 mm
MD	max	0.6 mm
OP		15.1 ± 0.6 mm

16 mm roller lever



MFI.7 **MFI.7S** **MFI.7ST** **MFI.7STP**

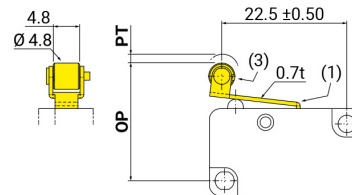

OF	max	4.5 N
RF	min	1.9 N
PT	max	1.8 mm
OT	min	0.8 mm
MD	max	0.6 mm
OP		21.1 ± 0.6 mm

Tower actuator with threaded flange



MFI.T

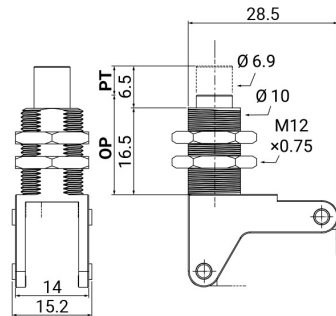

OF	max	6.0 N
RF	min	2.0 N
PT	max	2.2 mm
OT	min	3.3 mm
MD	max	0.5 mm
OP		21.2 ± 0.8 mm

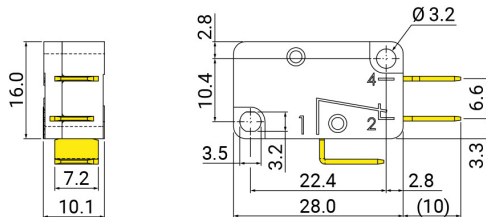

FASTON TERMINALS

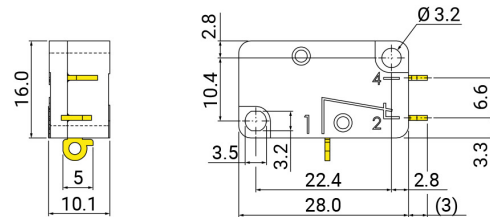

SOLDER TERMINALS

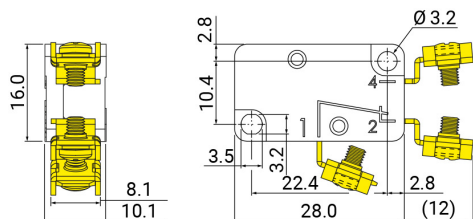

SCREW TERMINALS

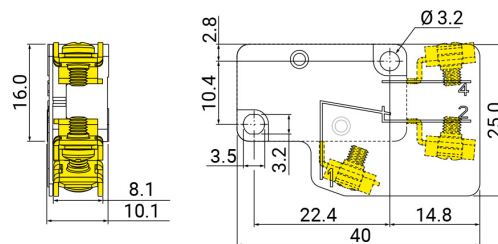

SCREW TERMINALS + PLATE PROTECTION