

Motor Cam Switches, Type R, Door or Thru Panel Mounting



COMPLY WITH RULES

IEC 947-3, EN 60947-3, UL508

SERIES		P012-P016-P020 PX12-PX16-PX20			C025-C032-C040 CX25-CX32-CX40			C063-C080		G125		G200	
Protection class	control EN 60529 (UL50) NEMA 4X control with knob only terminals	IP65 (Type 1 - 4 -4X) IP40 IP20 (P0) - IP10 (PX)			IP65 (Type 1 - 4 -4X) IP40 IP20 (P0) - IP10 (PX)			IP65 IP40 IP00		IP65 - IP00		IP65 - IP00	
Material group	EN 60947-1	II			II			II		IIIA		IIIA	
Pollution grade	EN 60947-1	3			3			3		3		3	
Flammability	UL94	VO (Live Electrical parts)			VO (Live Electrical parts)			VO (Live Electrical parts)		VO (Live Electrical parts)		VO (Live Electrical parts)	
Ambient temperature	°C	Operating: -40 +85 Storage: -40 +70			Operating: -40 +85 Storage: -40 +70			Operating: -40 +70 Storage: -40 +70		Operating: -15 +55 Storage: -25 +70		Operating: -15 +55 Storage: -25 +70	
Climate Withstand	IEC 68 part 2-3 IEC 68 part 2-30	Hot damp Unsettled hot damp			Hot damp Unsettled hot damp			Hot damp Unsettled hot damp		- -		- -	
Terminal screw identification		EN50013			EN50013			EN50013		-		-	
Connections	Terminal block caliber EN60947-1 Terminal screw Screwing torque EN60947-1	A3 M3,5 0,8 Nm (7,2 lb. in.) 7,5 lb. in. (0,85 Nm)			A5 M4 1,2 Nm (10,6 lb. in.) 12 lb. in. (1,4 Nm)			A7 2xM4 1,2 Nm (10,6 lb. in.) 10,62 lb. in. (1,2 Nm)		Hex. screw M8 for bars and cable lugs		Hex. screw M10 for bars and cable lugs	
Connectable section	Flexible conductors min/max AWG	mm ² 1x0,75/4 - 2x0,75/2,5 10 - 18			mm ² 2x2,5/10 14 - 6			mm ² 2,5/35 14 - 3		-		-	
	Solid conductors min/max AWG	mm ² 1x0,75/4 - 2x0,75/2,5 10 - 18			mm ² 2x2,5/10 14 - 6			mm ² 2,5/35 14 - 3		-		-	
Contacts		Double breaking			Double breaking			Double breaking		Double breaking		Double breaking	
Opening angles		30° - 45° - 60° - 90°			30° - 45° - 60° - 90°			45° - 60° - 90°		60° - 90°		60° - 90°	
Mechanical lifetime at 120 operations for hour	mil./cl	1	1	1	1	1	1	1	1	0,1	0,1	0,1	0,1
Electrical lifetime at 120 operations for hour	mil./cl	1	0,75	0,75	1	0,75	0,75	0,5	0,25	0,01	0,01	0,01	0,01
CERTIFICATIONS		P012 PX12	P016 PX16	P020 PX20	C025 CX25	C032 CX32	C040 CX40	C063	C080	G125		G200	
CE	CE mark - Europe	■	■	■	■	■	■	■	■	■		■	
cUL	cUL Listed - USA and Canada	●	●	●	●	●	●	●	●	●		●	
IMQ	IMQ Istituto Marchio Qualità - Italy	●	●	●	●	●	●	●	●	●		●	
CCC	CCC Cina	●	●	●	●	●	●	●	●	●		●	
EAC	EAC Russia	●	●	●	●	●	●	●	●	●		●	

■ Comply to the requirements by passed test. ● Approved.

Motor Cam Switches, Type R, Door or Thru Panel Mounting

EN 60947-3 CHARACTERISTICS			PO12 - PX12	PO16 - PX16	PO20 - PX20	CO25 - CX25	CO32 - CX32	CO40 - CX40	CO63	CO80	G125	G200
Rated operating voltage Ue	V		690	690	690	690	690	690	690	690	690	690
Rated insulation voltage Ui	V		690	690	690	690	690	690	690	690	690	690
Rated impulse withstand voltage Uimp (sectionable)	kV		4	4	4	6	6	6	8	8	6	6
Rated thermal current Ith	A		16	20	25	32	40	50	85	100	150	225
Rated thermal current in enclosed Ithe	A		12	16	20	25	32	40	85	100	150	225
Frequency	Hz		50/60	50/60	50/60	50/60	50/60	50/60	50/60	50/60	50/60	50/60
RATED OPERATING CURRENT Ie: alternate current			PO12 - PX12	PO16 - PX16	PO20 - PX20	CO25 - CX25	CO32 - CX32	CO40 - CX40	CO63	CO80	G125	G200
AC-21A Switching resistive loads with light overloads	690V	A	12	16	20	25	32	40	63	80	125	200
AC-22A Switching mixed resistive and inductive loads at light overloads	690V	A	12	16	20	25	32	40	63	80	125	200
AC-23A Periodic switching of motors	single phase - 1 pole	110V A/kW	12/1,1	14/1,5	18/2	25/1,5	30/2,2	35/3	45/4	63/5,5	-	-
		230V A/kW	12/2,2	14/3	18/4	25/4	30/5,5	35/6,5	45/7,5	63/11	-	-
		230V A/kW	10/3	14/4	16/5	25/7,5	30/9	35/11	50/15	58/18,5	140/45	169/55
		400V A/kW	10/5,5	14/7,5	16/9	22/11	24/15	32/18,5	40/22	54/30	78/45 (415V)	95/55 (415V)
		500V A/kW	10/7,5	14/10	16/11	22/11	27/18,5	32/22	40/30	54/37	65/45	79/55
AC3 Starting of cage motors (Interruption hile running)	single phase - 2 poles	110V A/kW	10/0,75	12/1,1	16/1,5	22/1,1	25/1,5	30/2,5	36/3,7	45/4	-	-
		230V A/kW	10/2	12/2,2	16/3,5	22/3,7	25/4	30/5,5	36/6,5	45/7,5	-	-
		230V A/kW	8/2,2	10/3	12/4	18/5,5	23/7,5	27/9	37/11	47/15	115/37	140/45
		400V A/kW	8/4	10/5	12/6	18/7,5	23/11	27/15	35/18,5	44/22	64/37 (415V)	78/45 (415V)
		500V A/kW	8/5,5	10/7,5	12/8	18/11	23/15	27/18,5	35/22	44/30	53/37	64/45
Nominal interruption power AC-23A (cosφ 0,45)		230V A	80	104	128	200	240	280	400	464	-	-
		400V A	80	104	128	176	216	256	320	432	-	-
		500V A	80	112	128	176	216	256	320	432	-	-
		690V A	80	112	128	160	176	200	256	320	-	-
Power dissipation for each pole	W	0,3*	0,35*	0,4*	-	-	-	-	-	-	-	
RATED OPERATING CURRENT Ie: direct current			PO12 - PX12	PO16 - PX16	PO20 - PX20	CO25 - CX25	CO32 - CX32	CO40 - CX40	CO63	CO80	G125	G200
DC-21A Switching resistive loads with light overloads	50V (1 phase)	A	10	12	16	20 ▼	25 ▼	32 ▼	-	-	-	-
DC-22A Switching mixed resistive and inductive loads at light overloads	30V (1 phase)	A	8	10	12	16 ▼	20 ▼	25 ▼	-	-	-	-
SHORT CIRCUIT CHARACTERISTICS			PO12 - PX12	PO16 - PX16	PO20 - PX20	CO25 - CX25	CO32 - CX32	CO40 - CX40	CO63	CO80	G125	G200
Rated short-time short circuit withstand current Icw (1 s)	A		300	300	300	500	500	500	1200	1200	-	-
Rated short circuit making capacity Icm	A		1200	1200	1200	2840	2840	2840	2000	2000	-	-
Conditional rated short circuit withstand current	kA		5	5	5	10	10	10	10	10	20	20
Fuse rating gG	690V	A	20	20	20	40 ■	40 ■	40 ■	100	100	125 ▲	200 ▲
UL 508 CHARACTERISTICS			PO12 - PX12	PO16 - PX16	PO20 - PX20	CO25 - CX25	CO32 - CX32	CO40 - CX40	CO63	CO80	G125	G200
General Use	600V AC	A	12	16	20	25	32	40	63	85	125	175
Standard motor load	single phase - 2 poles	120V AC HP (FLA)	0,5 (9,8)	1 (16)	1,5 (20)	1,5 (20)	2 (24)	3 (34)	5 (56)	5 (56)	-	-
		240V AC HP (FLA)	1 (8)	1,5 (10)	2 (12)	3 (17)	5 (28)	5 (28)	7,5 (40)	10 (50)	-	-
	3 phases - 3 poles	200V AC HP (FLA)	1,5 (6,9)	3 (11,04)	5 (17,5)	7,5 (25,3)	7,5 (25,3)	10 (32,2)	-	-	10 (56)	15 (84)
		240V AC HP (FLA)	3 (9,6)	5 (15,2)	5 (15,2)	7,5 (22)	7,5 (22)	10 (28)	15 (42)	20 (54)	20 (54)	25 (68)
		480V AC HP (FLA)	5 (7,6)	7,5 (11)	10 (14)	15 (21)	20 (27)	20 (27)	30 (40)	40 (52)	40 (52)	50 (65)
		600V AC HP (FLA)	5 (6,1)	7,5 (9)	10 (11)	15 (17)	20 (22)	20 (22)	40 (41)	50 (52)	50 (52)	50 (52)

▼ Values not reported on the IMQ files. ■ Fuses type gG 40a 500V ▲ Fuses type gG/Gm

| RANGE AC21A | 12A - 16A - 20A |

SCREW FIXING

Ø22 FIXING

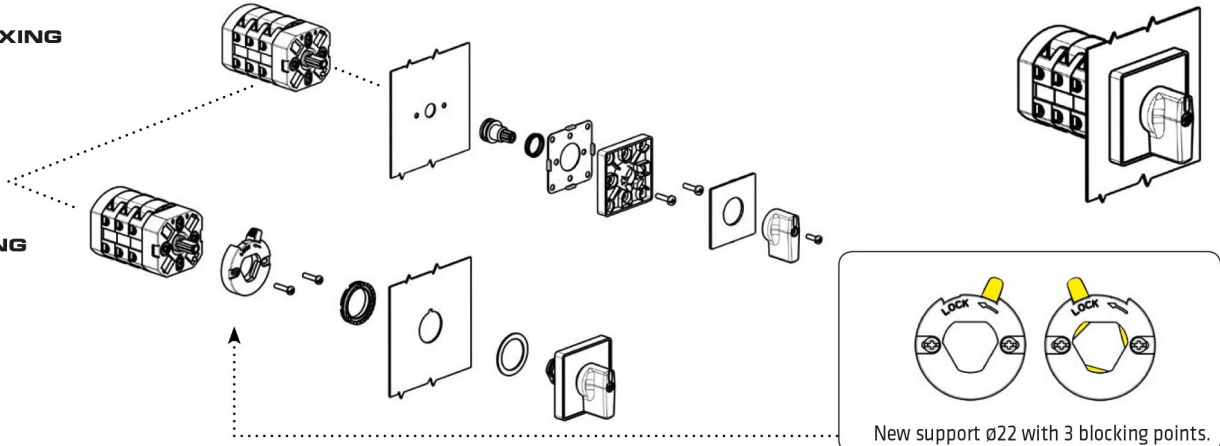

New support ø22 with 3 blocking points.

| RANGE AC21A | 25A - 32A - 40A |

SCREW FIXING

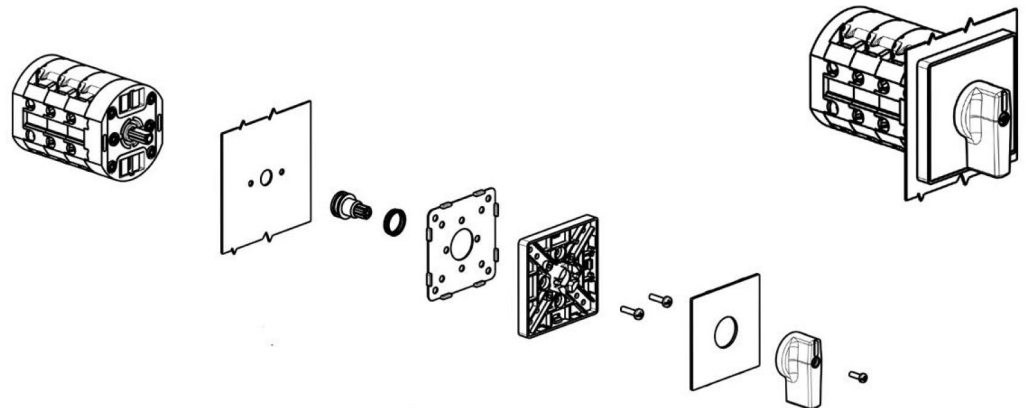

| RANGE AC21A | 63A - 80A |

SCREW FIXING

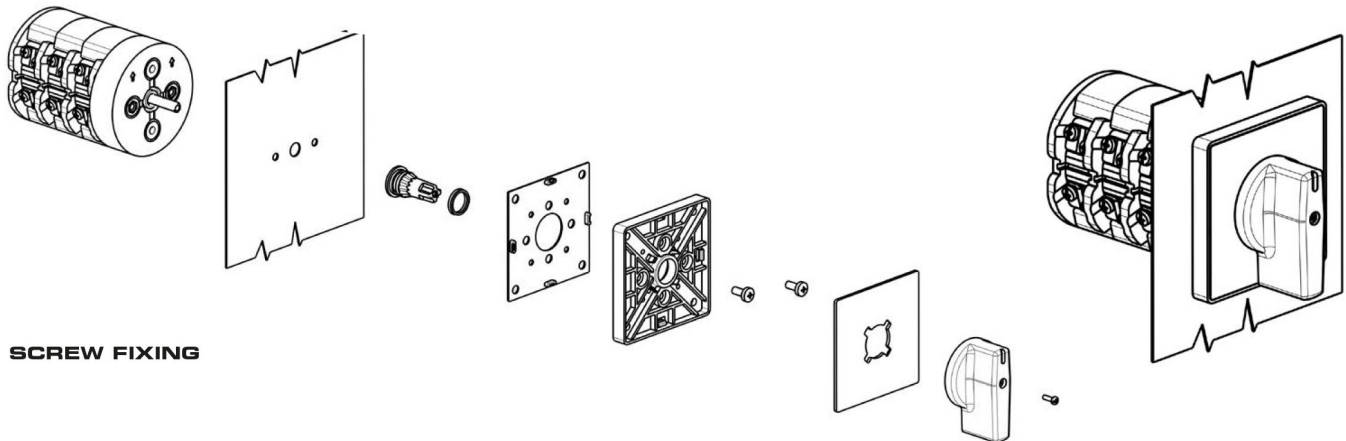

| RANGE AC21A | 125A |

SCREW FIXING

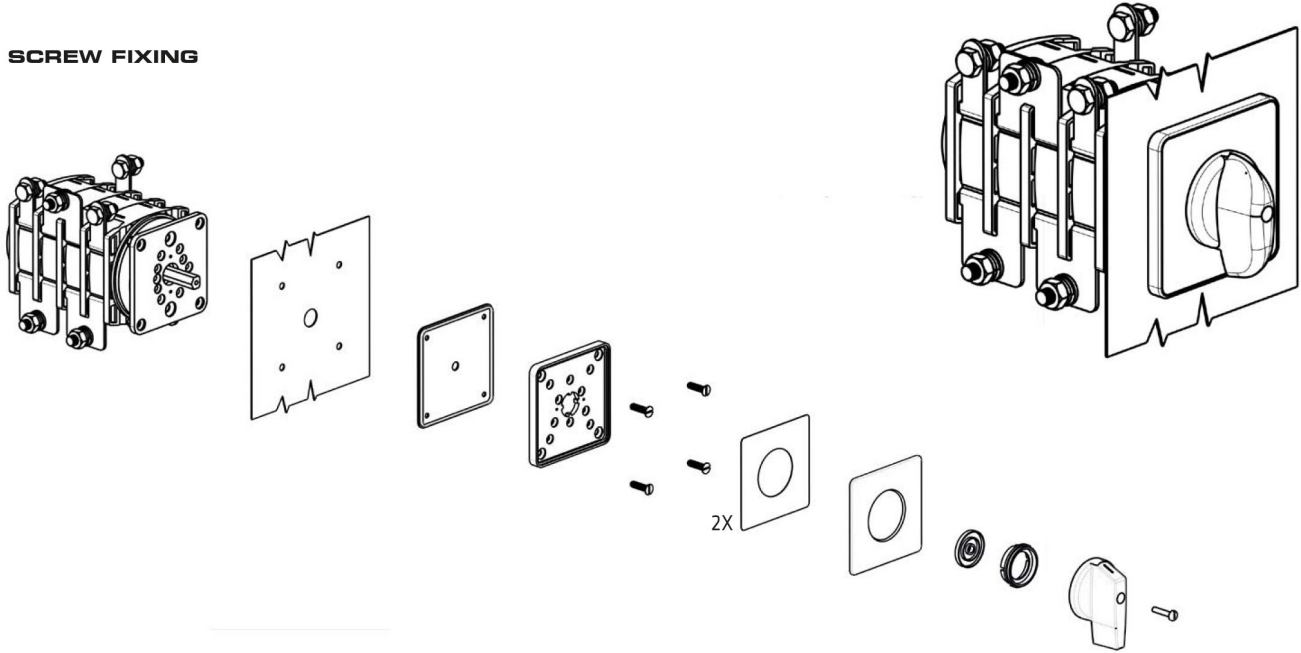

| RANGE AC21A | 200A |

SCREW FIXING

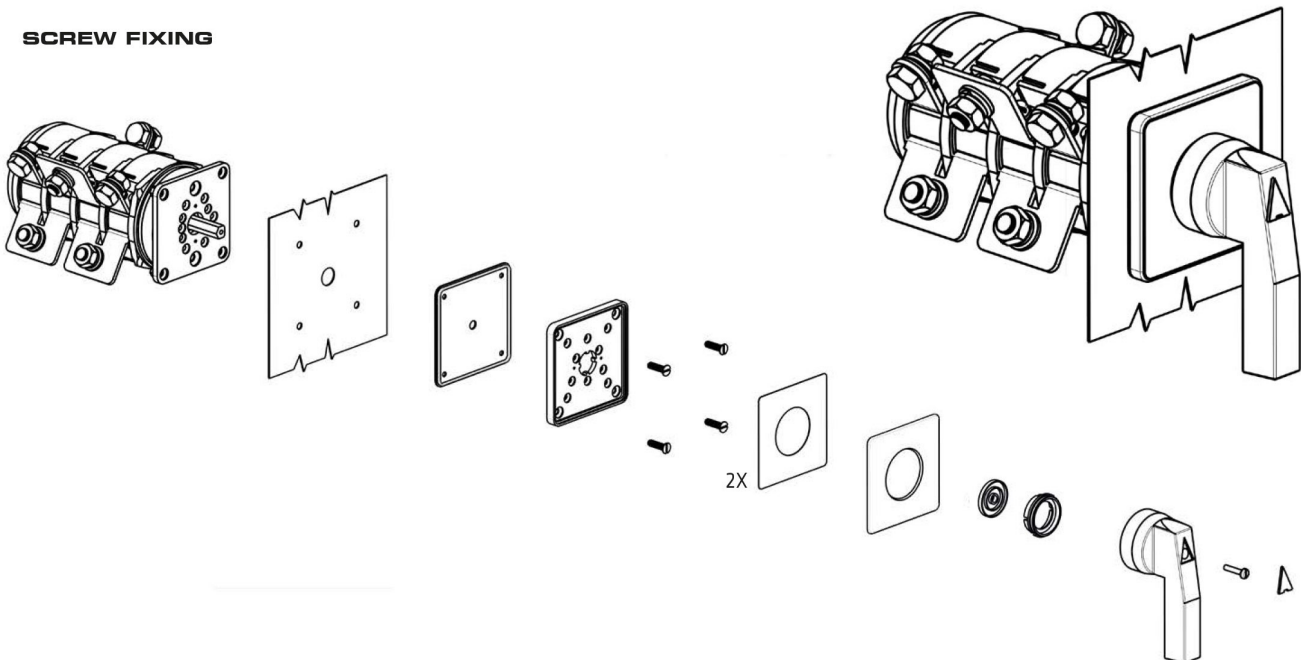



12-16-20A

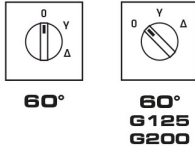

25-32-40A

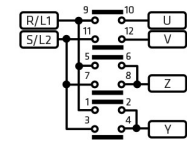
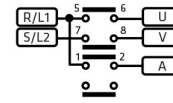
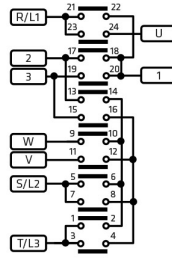
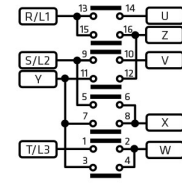



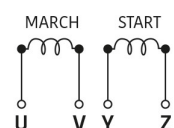
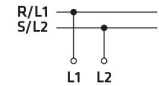
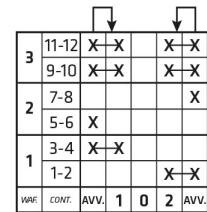
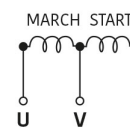
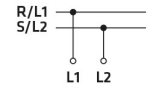
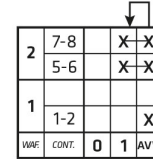
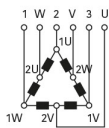
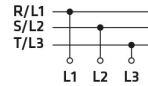
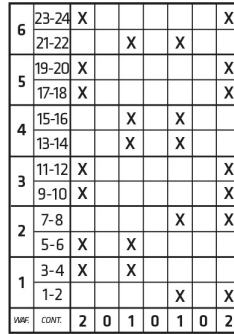
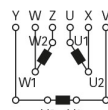
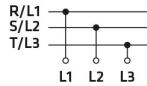
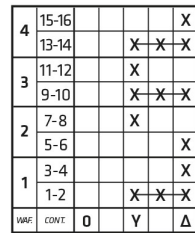



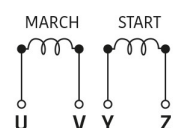
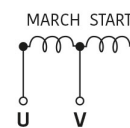
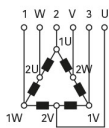
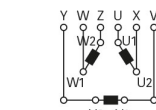











125A



200A



SERIES	AC21A	STAR-DELTA STARTER SWITCH	REVERSING-DAHLANDER POLE CHANGING TWO SPEED SWITCH	STARTER WITH SINGLE PHASE WITH AUXILIARY PHASE	REVERSING-STARTER SWITCH SINGLE PHASE WITH AUXILIARY PHASE
P012	12A	P0120015R	P0120031R	P0120017R	P0120018R
P016	16A	P0160015R	P0160031R	P0160017R	P0160018R
P020	20A	P0200015R	P0200031R	P0200017R	P0200018R
C025	25A	C0250015R	C0250031R	-	-
C032	32A	C0320015R	C0320031R	-	-
C040	40A	C0400015R	C0400031R	-	-
C063	63A	-	-	-	-
C080	80A	-	-	-	-
G125	125A	G1250015R	-	-	-
G200	200A	G2000015R	-	-	-

ACTUATOR	FIXING	P012 - P016 - P020					C025 - C032 C040		C063 - C080	G125	G200
		 60°	 45°	 45°	 45°	 NO	 60°	 45°	 60°	 60°	 60°
	screw	001/0015	001/0031	001/0017	001/0018	-	007/0015	007/0031	-	441/0015	461/0015
	ø22	056X/0015	056X/0031	056X/0017	056X/0018	-	-	-	-	-	-
	screw	002/0015	002/0031	002/0017	002/0018	-	008/0015	008/0031	-	-	-
	ø22	-	-	-	-	-	-	-	-	-	-
	screw	003/0015	003/0031	003/0017	003/0018	-	003/0015	003/0031	-	-	-
	ø22	-	-	-	-	-	-	-	-	-	-
	screw	004/0015	004/0031	004/0017	004/0018	-	004/0015	004/0031	-	-	-
	ø22	-	-	-	-	-	-	-	-	-	-
	screw	009/0015	009/0031	009/0017	009/0018	-	009/0015	009/0031	-	-	-
	ø22	-	-	-	-	-	-	-	-	-	-
	screw	010/0015	010/0031	010/0017	010/0018	-	010/0015	010/0031	-	-	-
	ø22	-	-	-	-	-	-	-	-	-	-
	ø22	-	-	-	-	-	-	-	-	-	-
	ø22	-	-	-	-	-	-	-	-	-	-
	ø22	-	-	-	-	028X	-	-	-	-	-
	ø22	-	-	-	-	029X	-	-	-	-	-

▲ UL50 NEMA Type 1-4-4X ▲ Key removable at 0° and 180° ▲ Body mounting rotated by 90°



12-16-2DA

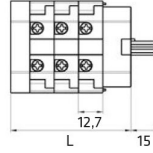
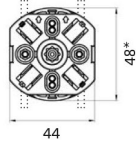

WAFER GAP	L x WAFER N°					
	1	2	3	4	5	6
12,7	37,4	50,1	62,8	75,5	88,2	100,9

* If cam switch is provided of external bridge (wafer to wafer) the height will be increased of ~ 2 mm for the lower and upper sides.



25-32-4DA

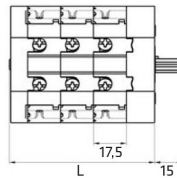
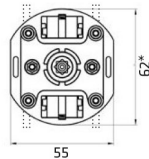

WAFER GAP	L x WAFER N°					
	1	2	3	4	5	6
17,5	42,2	59,7	77,2	94,7	112,2	129,7

* If cam switch is provided of external bridge (wafer to wafer) the height will be increased of ~ 1 mm for the lower and upper sides.



63-80A

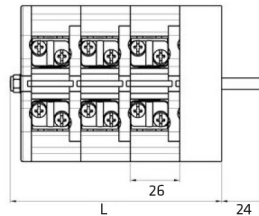
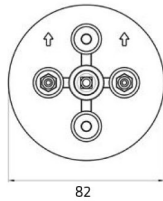

WAFER GAP	L x WAFER N°					
	1	2	3	4	5	6
26	59,1	85,1	111,1	137,1	163	189,1



125A

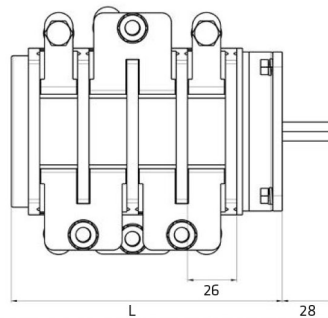
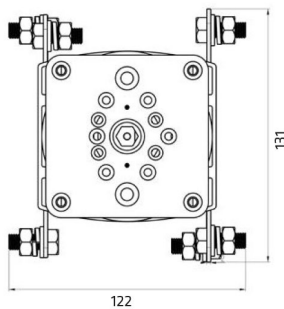

WAFER GAP	L x WAFER N°					
	1	2	3	4	5	6
26	66	92	118	144	170	196



200A

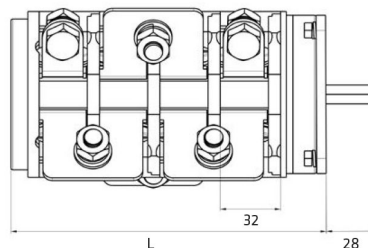
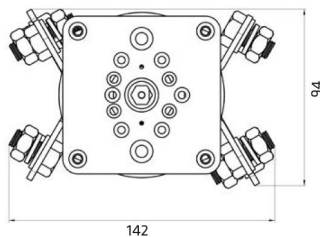

WAFER GAP	L x WAFER N°					
	1	2	3	4	5	6
32	72	104	136	168	200	232

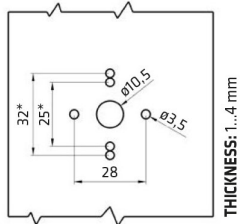

THICKNESS: 1...4 mm

FIXING:
Captive M3 bolt - 28 mm
* ALTERNATIVE FIXING
Screwplast 25 or 32 mm

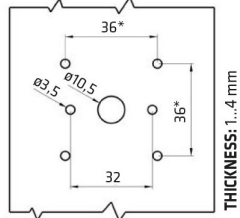
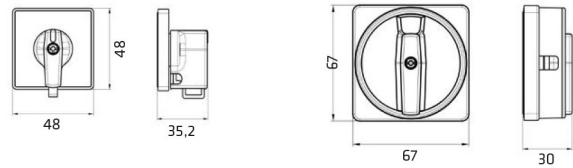
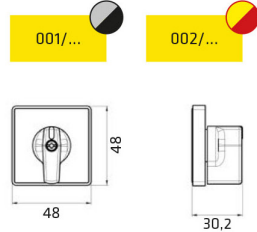

THICKNESS: 1...4 mm

FIXING:
Captive M3 bolt - 32 mm
* ALTERNATIVE FIXING
Screwplast \square 36 mm

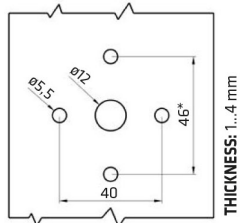
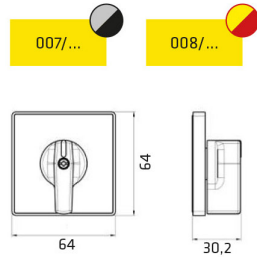

THICKNESS: 1...4 mm

FIXING:
Captive M5 bolt - 40 mm
* ALTERNATIVE FIXING
M5 - 46 mm

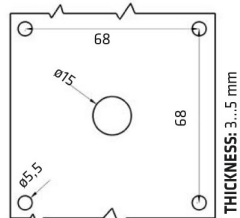
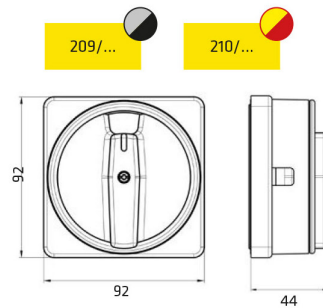
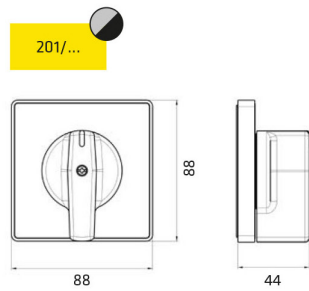

THICKNESS: 3...5 mm

FISSAGGIO:
M5 bolt \square 68 mm

